

A Review of Transients and Their Means of Suppression

Prepared by
 Steve Cherniak
 Applications Engineering



ON Semiconductor™

http://onsemi.com

APPLICATION NOTE

INTRODUCTION

One problem that most, if not all electronic equipment designers must deal with, is transient overvoltages. Transients in electrical circuits result from the sudden release of previously stored energy. Some transients may be voluntary and created in the circuit due to inductive switching, commutation voltage spikes, etc. and may be easily suppressed since their energy content is known and predictable. Other transients may be created outside the circuit and then coupled into it. These can be caused by lightning, substation problems, or other such phenomena. These transients, unlike switching transients, are beyond the control of the circuit designer and are more difficult to identify, measure and suppress.

Effective transient suppression requires that the impulse energy is dissipated in the added suppressor at a low enough voltage so the capabilities of the circuit or device will not be exceeded.

REOCCURRING TRANSIENTS

Transients may be formed from energy stored in circuit inductance and capacitance when electrical conditions in the circuit are abruptly changed.

Switching induced transients are a good example of this; the change in current ($\frac{di}{dt}$) in an inductor (L) will generate

a voltage equal to $L \frac{di}{dt}$. The energy (J) in the transient is equal to $1/2Li^2$ and usually exists as a high power impulse for a relatively short time ($J = Pt$).

If load 2 is shorted (Figure 1), devices parallel to it may be destroyed. When the fuse opens and interrupts the fault current, the slightly inductive power supply produces a transient voltage spike of $V = L \frac{di}{dt}$ with an energy content of $J = 1/2Li^2$. This transient might be beyond the voltage limitations of the rectifiers and/or load 1. Switching out a high current load will have a similar effect.

TRANSFORMER PRIMARY BEING ENERGIZED

If a transformer is energized at the peak of the line voltage (Figure 2), this voltage step function can couple to the stray capacitance and inductance of the secondary winding and generate an oscillating transient voltage whose oscillations depend on circuit inductance and capacitance. This transient's peak voltage can be up to twice the peak amplitude of the normal secondary voltage.

In addition to the above phenomena the capacitively coupled (C_S) voltage spike has no direct relationship with the turns ratio, so it is possible for the secondary circuit to see the peak applied primary voltage.

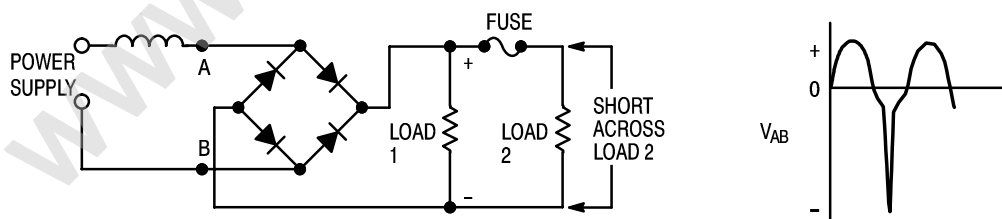

Figure 1. Load Dump with Inductive Power Supply

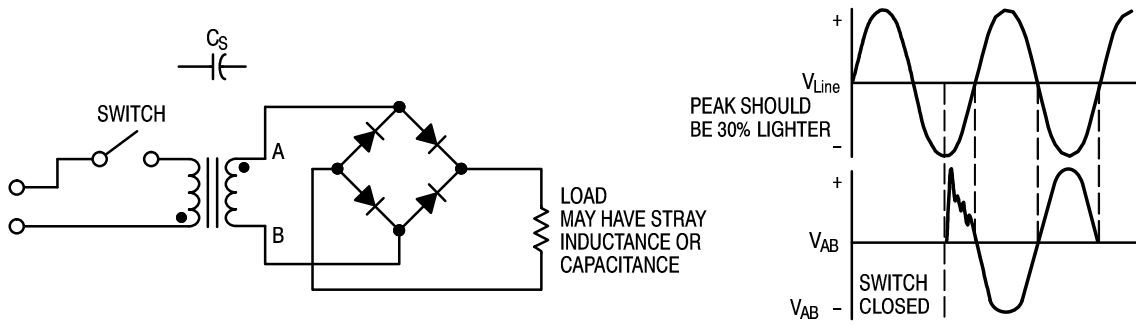

Figure 2. Situation Where Transformer Capacitance Causes a Transient

TRANSFORMER PRIMARY BEING DE-ENERGIZED

If the transformer is driving a high impedance load, transients of more than ten times normal voltage can be created at the secondary when the primary circuit of the transformer is opened during zero-voltage crossing of the ac line. This is due to the interruption of the transformer magnetizing current which causes a rapid collapse of the magnetic flux in the core. This, in turn, causes a high voltage transient to be coupled into the transformer's secondary winding (Figure 3).

Transients produced by interrupting transformers magnetizing current can be severe. These transients can destroy a rectifier diode or filter capacitor if a low impedance discharge path is not provided.

SWITCH "ARCING"

When a contact type switch opens and tries to interrupt current in an inductive circuit, the inductance tries to keep current flowing by charging stray capacitances. (See Figure 4.)

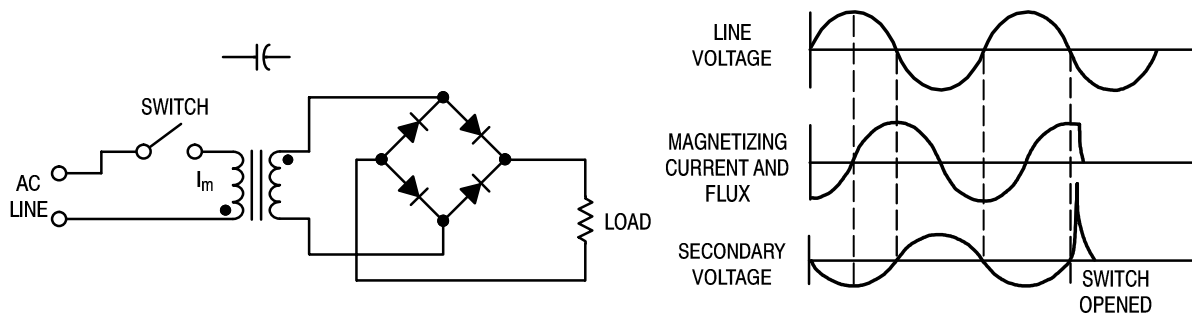

Figure 3. Typical Situation Showing Possible Transient When Interrupting Transformer Magnetizing Current

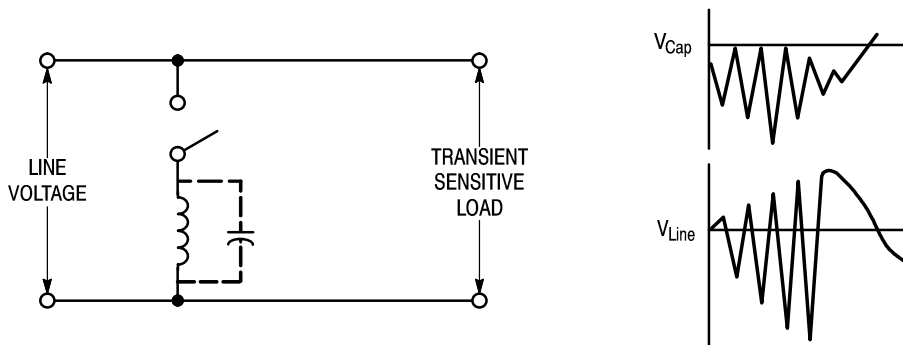

Figure 4. Transients Caused by Switch Opening

This can also happen when the switch contacts bounce open after its initial closing. When the switch is opened (or bounces open momentarily) the current that the inductance wants to keep flowing will oscillate between the stray capacitance and the inductance. When the voltage due to the oscillation rises at the contacts, breakdown of the contact gap is possible, since the switch opens (or bounces open) relatively slowly compared to the oscillation frequency, and the distance may be small enough to permit "arcing." The arc will discontinue at the zero current point of the oscillation, but as the oscillatory voltage builds up again and the contacts move further apart, each arc will occur at a higher voltage until the contacts are far enough apart to interrupt the current.

WAVESHAPES OF SURGE VOLTAGES

Indoor Waveshapes

Measurements in the field, laboratory, and theoretical calculations indicate that the majority of surge voltages in indoor low-voltage power systems have an oscillatory waveshape. This is because the voltage surge excites the natural resonant frequency of the indoor wiring system. In addition to being typically oscillatory, the surges can also have different amplitudes and waveshapes in the various places of the wiring system. The resonant frequency can range from about 5 kHz to over 500 kHz. A 100 kHz frequency is a realistic value for a typical surge voltage for most residential and light industrial ac wire systems.

The waveshape shown in Figure 5 is known as an "0.5 μs – 100 kHz ring wave." This waveshape is reasonably representative of indoor low-voltage (120 V – 240 V) wiring system transients based on measurements conducted by several independent organizations. The waveshape is defined as rising from 10% to 90% of its final amplitude in 0.5 μs, then decays while oscillating at 100 kHz, each peak being 60% of the preceding one.

The fast rise portion of the waveform can induce the effects associated with non-linear voltage distribution in windings or cause dv/dt problems in semiconductors. Shorter rise times can be found in transients but they are lengthened as they propagate into the wiring system or reflected from wiring discontinuities.

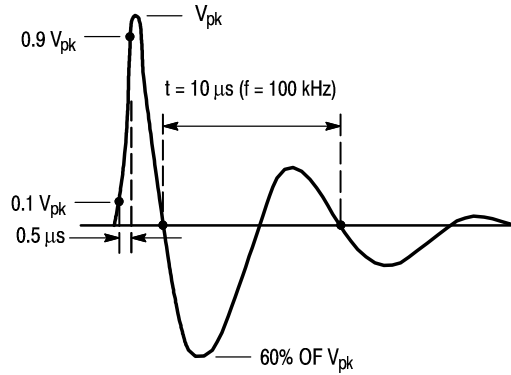

Figure 5. 0.5 μs 100 kHz Ring Wave

The oscillating portion of the waveform produces voltage polarity reversal effects. Some semiconductors are sensitive to polarity changes or can be damaged when forced into or out of conduction (i.e. reverse recovery of rectifier devices). The sensitivity of some semiconductors to the timing and polarity of a surge is one of the reasons for selecting this oscillatory waveform to represent actual conditions.

Outdoor Locations

Both oscillating and unidirectional transients have been recorded in outdoor environments (service entrances and other places nearby). In these locations substantial energy is still available in the transient, so the waveform used to model transient conditions outside buildings must contain greater energy than one used to model indoor transient surges.

Properly selected surge suppressors have a good reputation of successful performance when chosen in conjunction with the waveforms described in Figure 6. The recommended waveshape of 1.2 × 50 μs (1.2 μs is associated with the transients rise time and the 50 μs is the time it takes for the voltage to drop to 1/2Vpk) for the open circuit voltage and 8 × 20 μs for the short circuit current are as defined in IEEE standard 28-ANSI Standard C62.1 and can be considered a realistic representation of an outdoor transients waveshape.

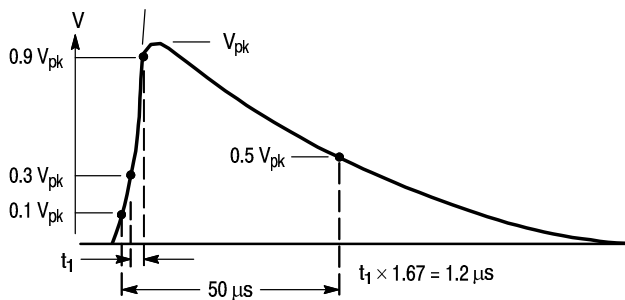

(a) Open-Circuit Voltage Waveform

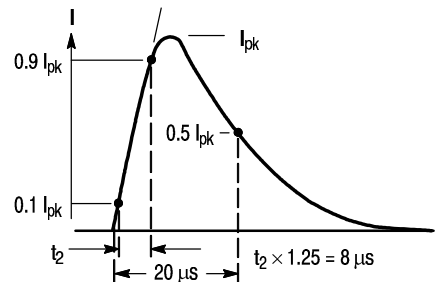

(b) Discharge Current Waveform

Figure 6. Unidirectional Wave Shapes

The type of device under test determines which waveshape in Figure 6 is more appropriate. The voltage waveform is normally used for insulation voltage withstand tests and the current waveform is usually used for discharge current tests.

RANDOM TRANSIENTS

The source powering the circuit or system is frequently the cause of transient induced problems or failures. These transients are difficult to deal with due to their nature; they are totally random and it is difficult to define their amplitude, duration and energy content. These transients are generally caused by switching parallel loads on the same

branch of a power distribution system and can also be caused by lightning.

AC POWER LINE TRANSIENTS

Transients on the ac power line range from just above normal voltage to several kV. The rate of occurrence of transients varies widely from one branch of a power distribution system to the next, although low-level transients occur more often than high-level surges.

Data from surge counters and other sources is the basis for the curves shown in Figure 7. This data was taken from unprotected (no voltage limiting devices) circuits meaning that the transient voltage is limited only by the sparkover distance of the wires in the distribution system.

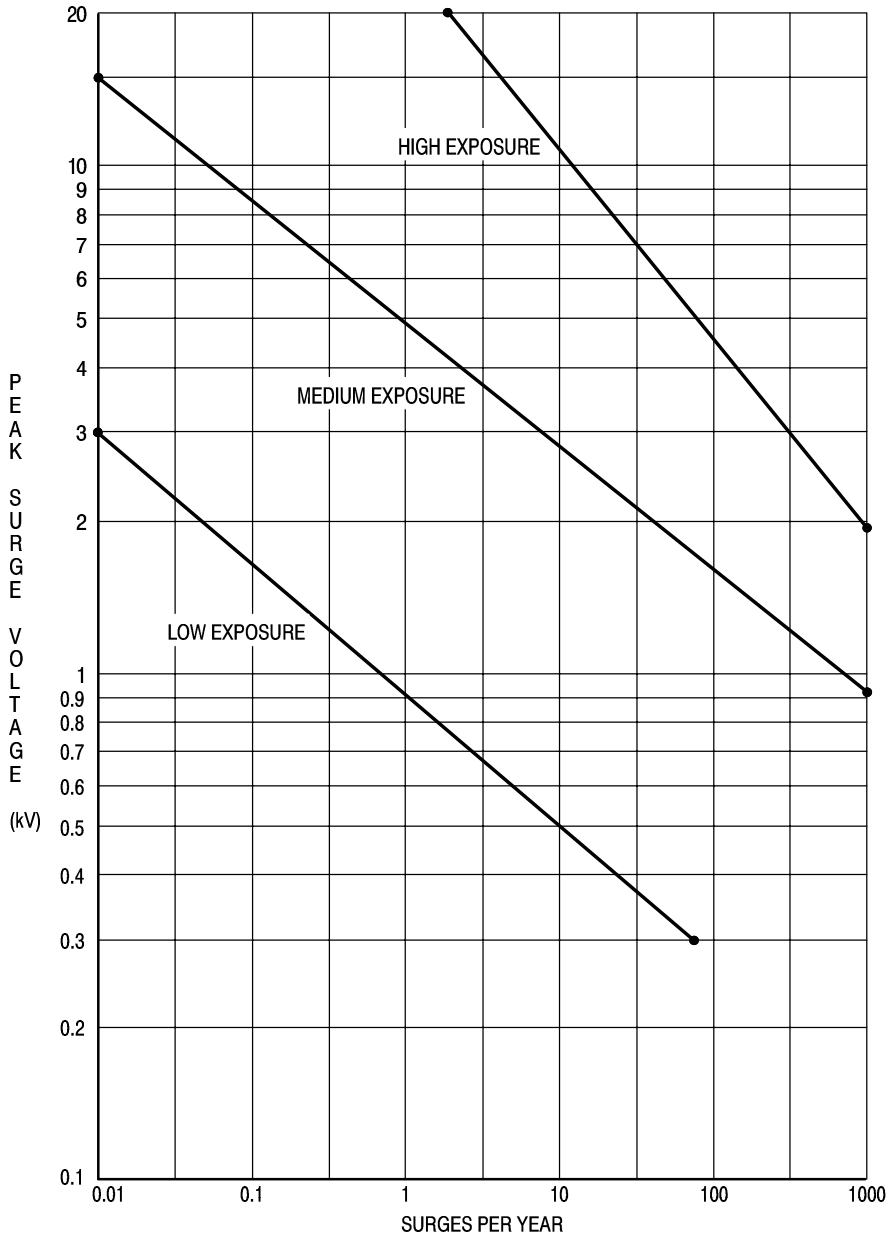

Figure 7. Peak Surge Voltage versus Surges per Year*

*EIA paper, P587.1/F, May, 1979, Page 10

The low exposure portion of the set of curves is data collected from systems with little load-switching activity that are located in areas of light lightning activity.

Medium exposure systems are in areas of frequent lightning activity with a severe switching transient problem.

High exposure systems are rare systems supplied by long overhead lines which supply installations that have high sparkover clearances and may be subject to reflections at power line ends.

When using Figure 7 it is helpful to remember that peak transient voltages will be limited to approximately 6 kV in indoor locations due to the spacing between conductors using standard wiring practices.

TRANSIENT ENERGY LEVELS AND SOURCE IMPEDANCE

The energy contained in a transient will be divided between the transient suppressor and the source impedance of the transient in a way that is determined by the two impedances. With a spark-gap type suppressor, the low impedance of the Arc after breakdown forces most of the transient's energy to be dissipated elsewhere, e.g. in a current limiting resistor in series with the spark-gap and/or in the transient's source impedance. Voltage clamping suppressors (e.g. zeners, mov's, rectifiers operating in the breakdown region) on the other hand absorb a large portion of the transient's surge energy. So it is necessary that a realistic assumption of the transient's source impedance be made in order to be able to select a device with an adequate surge capability.

The 100 kHz "Ring Wave" shown in Figure 5 is intended to represent a transient's waveshape across an open circuit. The waveshape will change when a load is connected and the amount of change will depend on the transient's source impedance. The surge suppressor must be able to withstand the current passed through it from the surge source. An assumption of too high a surge impedance (when testing the suppressor) will not subject the device under test to sufficient stresses, while an assumption of too low a surge impedance may subject it to an unrealistically large stress; there is a trade-off between the size (cost) of the suppressor and the amount of protection obtained.

In a building, the transient's source impedance increases with the distance from the electrical service entrance, but

open circuit voltages do not change very much throughout the structure since the wiring does not provide much attenuation. There are three categories of service locations that can represent the majority of locations from the electrical service entrance to the most remote wall outlet. These are listed below. Table 1 is intended as an aid for the preliminary selection of surge suppression devices, since it is very difficult to select a specific value of source impedance.

Category I: Outlets and circuits a "long distance" from electrical service entrance. Outlets more than 10 meters from Category II or more than 20 meters from Category III (wire gauge #14 – #10)

Category II: Major bus lines and circuits a "short distance" from electrical service entrance. Bus system in industrial plants. Outlets for heavy duty appliances that are "close" to the service entrance.

Distribution panel devices.

Commercial building lighting systems.

Category III. Electrical service entrance and outdoor locations.

Power line between pole and electrical service entrance.

Power line between distribution panel and meter.

Power line connection to additional near-by buildings.

Underground power lines leading to pumps, filters, etc.

Categories I and II in Table 1 correspond to the extreme range of the "medium exposure" curve in Figure 7. The surge voltage is limited to approximately 6 kV due to the sparkover spacing of indoor wiring.

The discharge currents of Category II were obtained from simulated lightning tests and field experience with suppressor performance.

The surge currents in Category I are less than in Category II because of the increase in surge impedance due to the fact that Category I is further away from the service entrance.

Category III can be compared to the "High Exposure" situation in Figure 7. The limiting effect of sparkover is not available here so the transient voltage can be quite large.

Category	Waveform	Surge Voltage ⁽¹⁾	Surge Current ⁽²⁾	Energy (Joules) Dissipated in a Suppressor with a Clamping Voltage of ⁽³⁾		
				250 V	500 V	1000 V
I	0.5 μ s 100 kHz Ring Wave	6 kV	200 A	0.4	0.8	1.6
II	0.5 μ s 100 kHz Ring Wave	6 kV	500 A	1	2	4
	1.2 \times 50 μ s 8 \times 20 μ s	6 kV	3 kA	20	40	80
III	1.2 \times 50 μ s 8 \times 20 μ s	10 kV or more	10 kA or more			

Notes: 1. Open Circuit voltage

2. Discharge current of the surge (not the short circuit current of the power system)

3. The energy a suppressor will dissipate varies in proportion with the suppressor's clamping voltage, which can be different with different system voltages (assuming the same discharge current).

LIGHTNING TRANSIENTS

There are several mechanisms in which lightning can produce surge voltages on power distribution lines. One of them is a direct lightning strike to a primary (before the substation) circuit. When this high current, that is injected into the power line, flows through ground resistance and the surge impedance of the conductors, very large transient voltages will be produced. If the lightning misses the primary power line but hits a nearby object the lightning discharge may also induce large voltage transients on the line. When a primary circuit surge arrester operates and limits the primary voltage the rapid dv/dt produced will effectively couple transients to the secondary circuit through the capacitance of the transformer (substation) windings in addition to those coupled into the secondary circuit by normal transformer action. If lightning struck the secondary circuit directly, very high currents may be involved which would exceed the capability of conventional surge suppressors. Lightning ground current flow resulting from nearby direct to ground discharges can couple onto the common ground impedance paths of the grounding networks also causing transients.

AUTOMOTIVE TRANSIENTS

Transients in the automotive environment can range from the noise generated by the ignition system and the various accessories (radio, power window, etc.) to the potentially destructive high energy transients caused by the charging (alternator/regulator) system. The automotive "Load

Dump" can cause the most destructive transients; it is when the battery becomes disconnected from the charging system during high charging rates. This is not unlikely when one considers bad battery connections due to corrosion or other wiring problems. Other problems can exist such as steady state overvoltages caused by regulator failure or 24 V battery jump starts. There is even the possibility of incorrect battery connection (reverse polarity).

Capacitive and/or inductive coupling in wire harnesses as well as conductive coupling (common ground) can transmit these transients to the inputs and outputs of automotive electronics.

The Society of Automotive Engineers (SAE) documented a table describing automotive transients (see Table 2) which is useful when trying to provide transient protection.

Considerable variation has been observed while gathering data on automobile transients. All automobiles have their electrical systems set up differently and it is not the intent of this paper to suggest a protection level that is required. There will always be a trade-off between cost of the suppressor and the level of protection obtained. The concept of one master suppressor placed on the main power lines is the most cost-effective scheme possible since individual suppressors at the various electronic devices will each have to suppress the largest transient that is likely to appear (Load Dump), hence each individual suppressor would have to be the same size as the one master suppressor since it is unlikely for several suppressors to share the transient discharge.

Table 2. Typical Transients Encountered in the Automotive Environment

Length of Transient	Cause	Energy Capability	Possible Frequency of Application
		Voltage Amplitude	
Steady State	Failed Voltage Regulator	∞	Infrequent
		+18 V	
5 Minutes	Booster starts with 24 V battery	∞	Infrequent
		± 24 V	
4.5–100 ms	Load Dump — i.e., disconnection of battery during high charging rates	≥ 10 J	Infrequent
		≤ 125 V	
≤ 0.32 s	Inductive Load Switching Transient	< 1 J	Often
		–300 V to +80 V	
≤ 0.2 s	Alternator Field Decay	< 1 J	Each Turn-Off
		–100 V to –40 V	
90 ms	Ignition Pulse Disconnected Battery	< 0.5 J	≤ 500 Hz Several Times in vehicle life
		≤ 75 V	
1 ms	Mutual Coupling in Harness	< 1 J	Often
		≤ 200 V	
15 μ s	Ignition Pulse Normal	< 0.001 J	3 500 Hz Continuous
		3 V	
	Accessory Noise	≤ 1.5 V	50 Hz to 10 kHz
	Transceiver Feedback	≈ 20 mV	R.F.

There will, of course, be instances where a need for individual suppressors at the individual accessories will be required, depending on the particular wiring system or situation.

TRANSIENT SUPPRESSOR TYPES

Carbon Block Spark Gap

This is the oldest and most commonly used transient suppressor in power distribution and telecommunication systems. The device consists of two carbon block electrodes separated by an air gap, usually 3 to 4 mils apart. One electrode is connected to the system ground and the other to the signal cable conductor. When a transient over-voltage appears, its energy is dissipated in the arc that forms between the two electrodes, a resistor in series with the gap, and also in the transient's source impedance, which depends on conductor length, material and other parameters.

The carbon block gap is a fairly inexpensive suppressor but it has some serious problems. One is that it has a relatively short service life and the other is that there are large variations in its arcing voltage. This is the major problem since a nominal 3 mil gap will arc anywhere from 300 to 1000 volts. This arcing voltage variation limits its use mainly to primary transient suppression with more accurate suppressors to keep transient voltages below an acceptable level.

Gas Tubes

The gas tube is another common transient suppressor, especially in telecommunication systems. It is made of two metallic conductors usually separated by 10 to 15 mils encapsulated in a glass envelope which is filled with several gases at low pressure. Gas tubes have a higher current carrying capability and longer life than carbon block gaps. The possibility of seal leakage and the resultant loss of protection has limited the use of these devices.

Selenium Rectifiers

Selenium transient suppressors are selenium rectifiers used in the reverse breakdown mode to clamp voltage transients. Some of these devices have self-healing properties which allows the device to survive energy discharges greater than their maximum capability for a limited number of surges. Selenium rectifiers do not have the voltage clamping capability of zener diodes. This is causing their usage to become more and more limited.

METAL OXIDE VARISTORS (MOV'S)

An MOV is a non-linear resistor which is voltage dependent and has electrical characteristics similar to back-to-back zener diodes. As its name implies it is made up of metal oxides, mostly zinc oxide with other oxides added to control electrical characteristics. MOV characteristics are compared to back-to-back zeners in Photos 2 through 7.

When constructing MOV's the metal oxides are sintered at high temperatures to produce a polycrystalline structure of conductive zinc oxide separated by highly resistive

intergranular boundaries. These boundaries are the source of the MOV's non-linear electrical behavior.

MOV electrical characteristics are mainly controlled by the physical dimensions of the polycrystalline structure since conduction occurs between the zinc oxide grains and the intergranular boundaries which are distributed throughout the bulk of the device.

The MOV polycrystalline body is usually formed into the shape of a disc. The energy rating is determined by the device's volume, voltage rating by its thickness, and current handling capability by its area. Since the energy dissipated in the device is spread throughout its entire metal oxide volume, MOV's are well suited for single shot high power transient suppression applications where good clamping capability is not required.

The major disadvantages with using MOV's are that they can only dissipate relatively small amounts of average power and are not suitable for many repetitive applications. Another drawback with MOV's is that their voltage clamping capability is not as good as zeners, and is insufficient in many applications.

Perhaps the major difficulty with MOV's is that they have a limited life time even when used below their maximum ratings. For example, a particular MOV with a peak current handling capability of 1000 A has a lifetime of about 1 surge at 1000 A_{pk}, 100 surges at 100 A_{pk} and approximately 1000 surges at 65 A_{pk}.

TRANSIENT SUPPRESSION USING ZENERS

Zener diodes exhibit a very high impedance below the zener voltage (V_Z), and a very low impedance above V_Z . Because of these excellent clipping characteristics, the zener diode is often used to suppress transients. Zeners are intolerant of excessive stress so it is important to know the power handling capability for short pulse durations.

Most zeners handle less than their rated power during normal applications and are designed to operate most effectively at this low level. Zener transient suppressors such as the ON Semiconductor 1N6267 Mosorb series are designed to take large, short duration power pulses.

This is accomplished by enlarging the chip and the effective junction area to withstand the high energy surges. The package size is usually kept as small as possible to provide space efficiency in the circuit layout, and since the package does not differ greatly from other standard zener packages, the steady state power dissipation does not differ greatly.

Some data sheets contain information on short pulse surge capability. When this information is not available for ON Semiconductor devices, Figure 8 can be used. This data applies for non-repetitive conditions with a lead temperature of 25°C.

It is necessary to determine the pulse width and peak power of the transient being suppressed when using Figure 8. This can be done by taking whatever waveform

the transient is and approximating it with a rectangular pulse with the same peak power. For example, an exponential discharge with a 1 ms time constant can be approximated by a rectangular pulse 1 ms wide that has the same peak power as the transient. This would be a better approximation than a rectangular pulse 10 ms wide with a correspondingly lower amplitude. This is because the heating effects of different pulse width lengths affect the power handling capability, as can be seen by Figure 8. This also represents a conservative approach because the exponential discharge will contain $\approx 1/2$ the energy of a rectangular pulse with the same pulse width and amplitude.

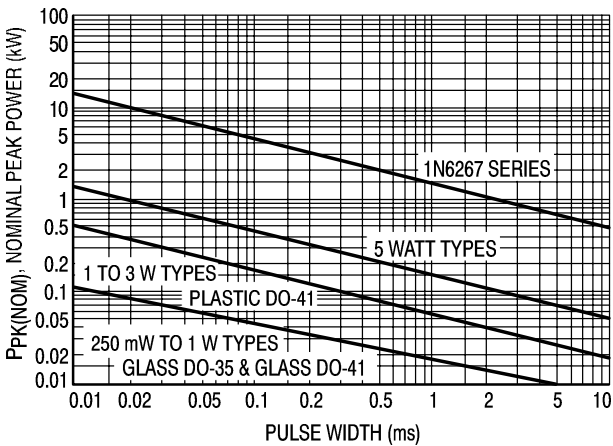

Figure 8. Peak Power Ratings of Zener Diodes

When used in repetitive applications, the peak power must be reduced as indicated by the curves of Figure 9. Average power must be derated as the lead or ambient temperature exceeds 25°C. The power derating curve normally given on data sheets can be normalized and used for this purpose.

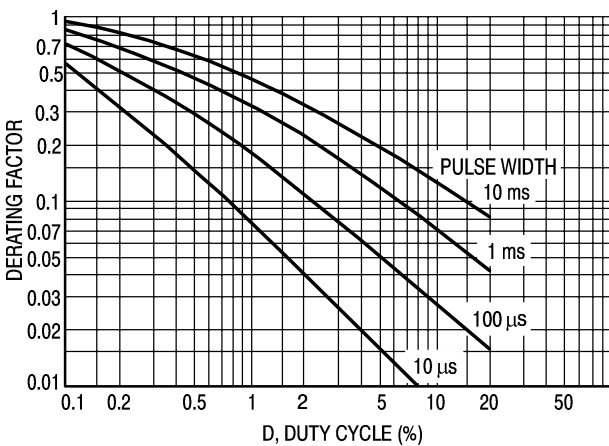

Figure 9. Typical Derating Factor for Duty Cycle

The peak zener voltage during the peak current of the transient being suppressed can be related to the nominal zener voltage (Eqtn 1) by the clamping factor (F_C).

$$\text{Eqtn 1: } V_{Z(pK)} = F_C (V_{Z(nom)})$$

Unless otherwise specified F_C is approximately 1.20 for zener diodes when operated at their pulse power limits.

For example, a 5 watt, 20 volt zener can be expected to show a peak voltage of 24 volts regardless of whether it is handling 450 watts for 0.1 ms or 50 watts for 10 ms. (See Figure 8.)

This occurs because the zener voltage is a function of both junction temperature and IR drop. Longer pulse widths cause a greater junction temperature rise than short ones; the increase in junction temperature slightly increases the zener voltage. This increase in zener voltage due to heating is roughly offset by the fact that longer pulse widths of identical energy content have lower peak currents. This results in a lower IR drop (zener voltage drop) keeping the clamping factor relatively constant with various pulse widths of identical energy content.

An approximation of zener impedance is also helpful in the design of transient protection circuits. The value of $R_{Z(nom)}$ (Eqtn 2) is approximate because both the clamping factor and the actual resistance is a function of temperature.

$$\text{Eqtn 2: } R_{Z(nom)} = \frac{V_{Z(nom)}^2 (F_C - 1)}{P_{pK(nom)}}$$

$V_{Z(nom)}$ = Nominal Zener Voltage

$P_{pK(nom)}$ = Found from Figure 8 when device type and pulse width are known. For example, from Figure 8 a 1N6267 zener suppressor has a $P_{pK(nom)}$ of 1.5 kW at a pulse width of 1 ms.

As seen from equation 2, zeners with a larger $P_{pK(nom)}$ capability will have a lower $R_{Z(nom)}$.

ZENER versus MOV TRADEOFFS

The clamping characteristics of Zeners and MOV's are best compared by measuring their voltages under transient conditions. Photos 1 through 9 are the result of an experiment that was done to compare the clamping characteristics of a Zener (ON Semiconductor 1N6281, approximately 1.5J capability) with those of an MOV (G.E. V27ZA4, 4J capability); both are 27 V devices.

Photo 1 shows the pulse generator output voltage. This generator synthesizes a transient pulse that is characteristic of those that may appear in the real world.

Photos 2 and 3 are clamping voltages of the MOV and Zener, respectively with a surge source impedance of 500 Ω.

Photos 4 and 5 are the clamping voltages with a surge source impedance of 50 Ω.

Photos 6 and 7 simulate a condition where the surge source impedance is 5 Ω.

Photos 8 and 9 show a surge source impedance of 0.55 Ω, which is at the limits of the Zener suppressor's capability.

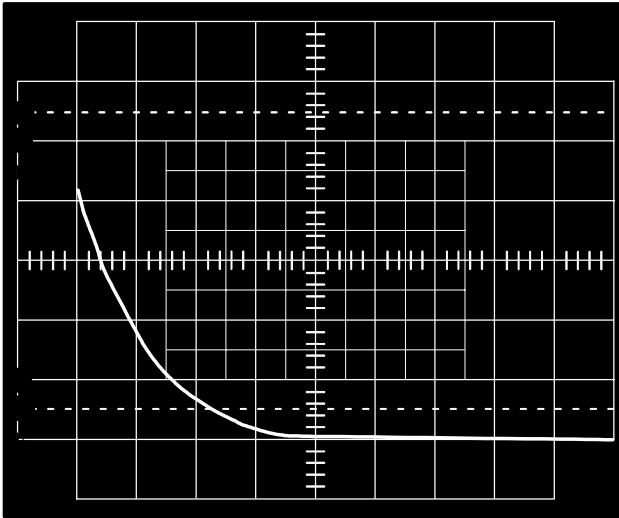

PHOTO 1
Open Circuit Transient Pulse
Vert: 20 V/div
Horiz: 0.5 ms/div
 $V_{\text{peak}} = 90 \text{ V}$

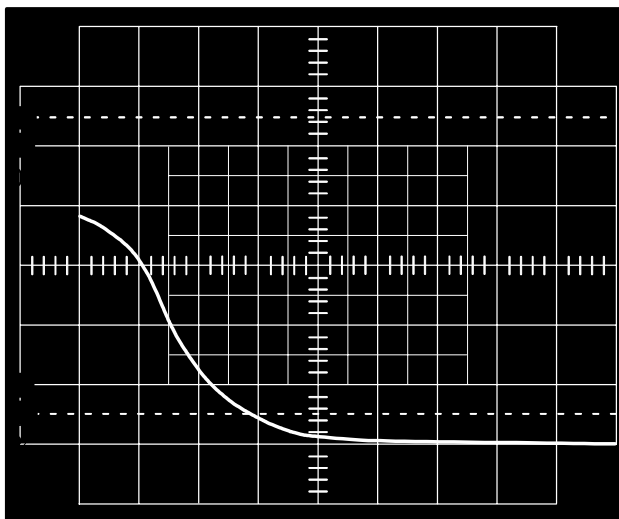

PHOTO 2
MOV (27 V)
Vert: 10 V/div
Horiz: 0.5 ms/div
Transient Source Impedance: 500Ω
 $V_{\text{peak}} = 39.9 \text{ V}$

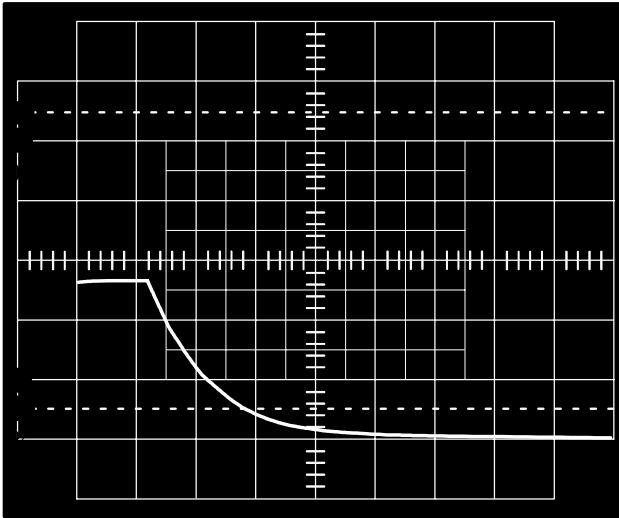

PHOTO 3
Zener (27 V)
Vert: 10 V/div
Horiz: 0.5 ms/div
Transient Source Impedance: 500 Ω
 $V_{\text{peak}} = 27 \text{ V}$

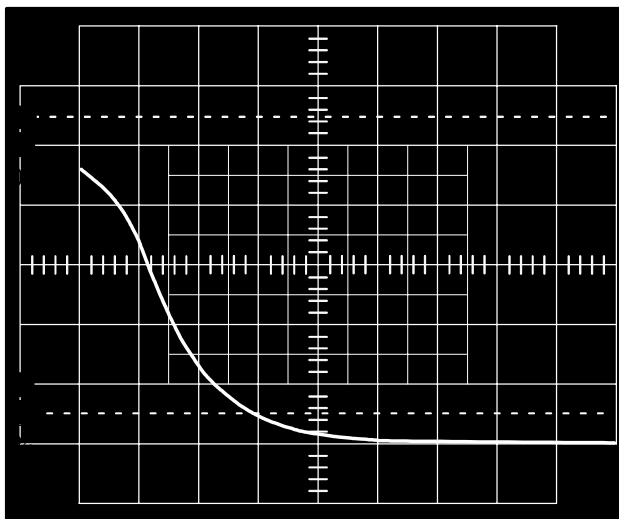

PHOTO 4
MOV (27 V)
Vert: 10 V/div
Horiz: 0.5 ms/div
Transient Source Impedance: 50 Ω
 $V_{\text{peak}} = 44.7 \text{ V}$

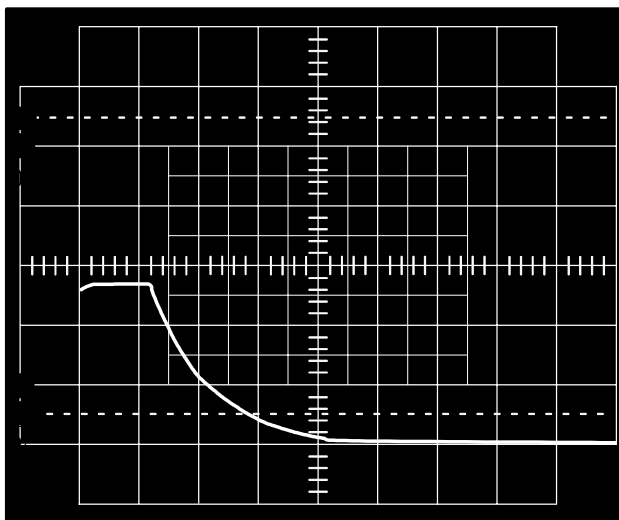

PHOTO 5
Zener (27 V)
Vert: 10 V/div
Horiz: 0.5 ms/div
Transient Source Impedance: 50 Ω
 $V_{\text{peak}} = 27 \text{ V}$

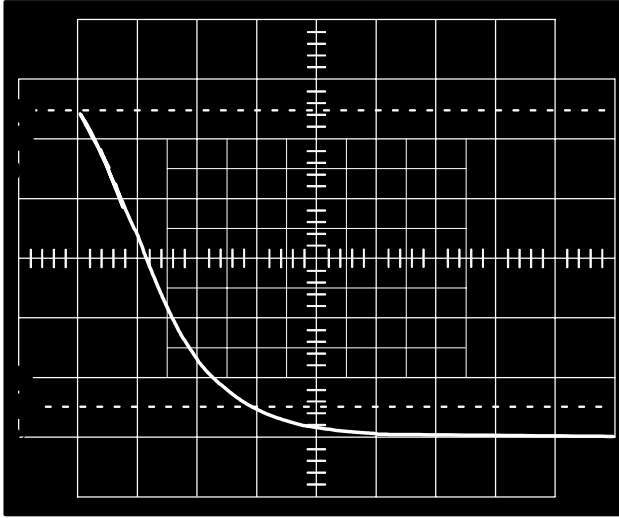

PHOTO 6
MOV (27 V)
Vert: 10 V/div
Horiz: 0.5 ms/div
Transient Source Impedance: 5 Ω
 $V_{\text{peak}} = 52 \text{ V}$

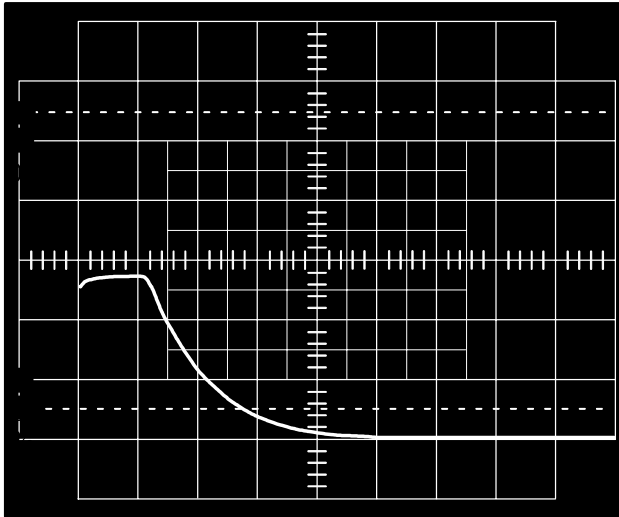

PHOTO 7
Zener (27 V)
Vert: 10 V/div
Horiz: 0.5 ms/div
Transient Source Impedance: 5 Ω
 $V_{\text{peak}} = 28 \text{ V}$

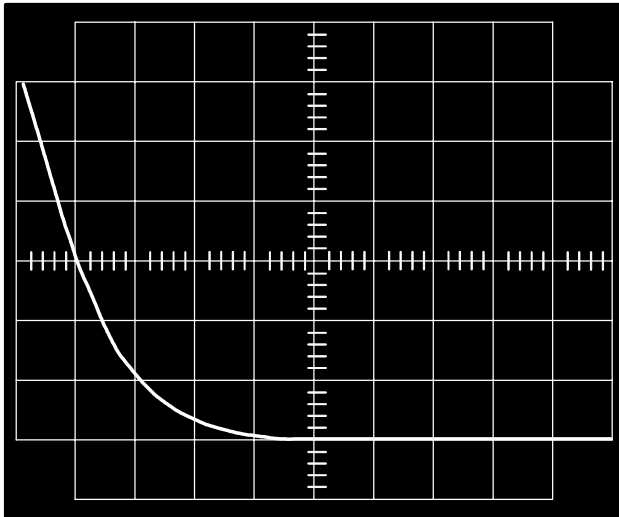
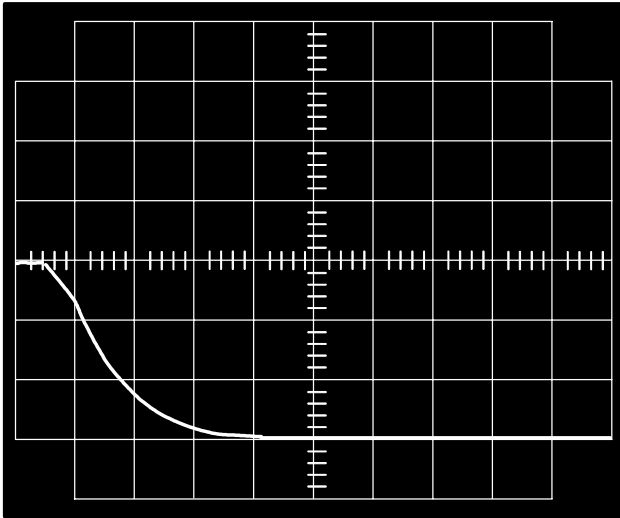

PHOTO 8
MOV (27 V)
Vert: 10 V/div
Horiz: 0.5 ms/div
Transient Source Impedance: 0.55 Ω
 $V_{\text{peak}} = 62.5 \text{ V}$

**PHOTO 9**

Zener (27 V)
 Vert: 10 V/div
 Horiz: 0.5 ms/div
 Transient Source Impedance: 0.55Ω
 V_{peak} : 30.2 V
 Peak Power: Approx 2000 W_{peak}
 (The limit of this device's capability)

As can be seen by the photographs, the Zener suppressor has significantly better voltage clamping characteristics than the MOV even though that particular Zener has less than one-fourth the energy capability of the MOV it was compared with. However, the energy rating can be misleading because it is based on the clamp voltage times the surge current, and when using an MOV, the high impedance results in a fairly high clamp voltage. The major tradeoff with using a zener type suppressor is its cost versus power handling capability, but since it would take an "oversized" MOV to clamp voltages (suppress transients) as well as the zener, the MOV begins to lose its cost advantage.

If a transient should come along that exceeds the capabilities of the particular Zener, or MOV, suppressor that was chosen, the load will still be protected, since they both fail short.

The theoretical reaction time for Zeners is in the picosecond range, but this is slowed down somewhat with lead and package inductance. The 1N6267 Mosorb series of transient suppressors have a typical response time of less than one nanosecond. For very fast rising transients it is important to minimize external inductances (due to wiring, etc.) which will minimize overshoot.

Connecting Zeners in a back-to-back arrangement will enable bidirectional voltage clamping characteristics. (See Figure 10.)

If Zeners A and B are the same voltage, a transient of either polarity will be clamped at approximately that voltage since one Zener will be in reverse bias mode while the other will be in the forward bias mode. When clamping low voltage it may be necessary to consider the forward drop of the forward biased Zener.

The typical protection circuit is shown in Figure 11a. In almost every application, the transient suppression device is placed in parallel with the load, or component to be protected. Since the main purpose of the circuit is to clamp the voltage appearing across the load, the suppressor should

be placed as close to the load as possible to minimize overshoot due to wiring (or any inductive) effect. (See Figure 11b.)

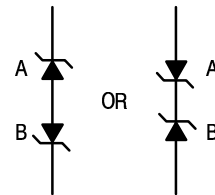
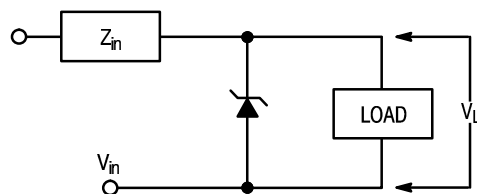
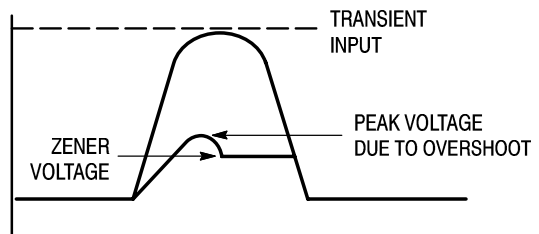
**Figure 10. Zener Arrangement for Bidirectional Clamping****Figure 11a. Using Zener to Protect Load Against Transients****Figure 11b. Overshoot Due to Inductive Effect**

Zener capacitance prior to breakdown is quite small (for example, the 1N6281 27 Volt Mosorb has a typical capacitance of 800 pF). Capacitance this small is desirable in the off-state since it will not attenuate wide-band signals.

When the Zener is in the breakdown mode of operation (e.g. when suppressing a transient) its effective capacitance increases drastically from what it was in the off-state. This makes the Zener ideal for parallel protection schemes since, during transient suppression, its large effective capacitance will tend to hold the voltage across the protected element constant; while in the off-state (normal conditions, no transient present), its low off-state capacitance will not attenuate high frequency signals.

Input impedance (Z_{in}) always exists due to wiring and transient source impedance, but Z_{in} should be increased as much as possible with an external resistor, if circuit constraints allow. This will minimize Zener stress.

CONCLUSION

The reliable use of semiconductor devices requires that the circuit designer consider the possibility of transient overvoltages destroying these transient-sensitive components.

These transients may be generated by normal circuit operations such as inductive switching circuits, energizing and deenergizing transformer primaries, etc. They do not present much of a problem since their energy content, duration and effect may easily be obtained and dealt with.

Random transients found on power lines, or lightning transients, present a greater threat to electronic components since there is no way to be sure when or how severe they will be. General guidelines were discussed to aid the circuit designer in deciding what size (capability and cost) suppressor to choose for a certain level of protection. There will always be a tradeoff between suppressor price and protection obtained.

Several different suppression devices were discussed with emphasis on Zeners and MOV's, since these are the most popular devices to use in most applications.

REFERENCES

1. GE Transient Voltage Suppression Manual, 2nd edition.
2. ON Semiconductor Zener Diode Manual.

Notes

Notes

ON Semiconductor and  are trademarks of Semiconductor Components Industries, LLC (SCILLC). SCILLC reserves the right to make changes without further notice to any products herein. SCILLC makes no warranty, representation or guarantee regarding the suitability of its products for any particular purpose, nor does SCILLC assume any liability arising out of the application or use of any product or circuit, and specifically disclaims any and all liability, including without limitation special, consequential or incidental damages. "Typical" parameters which may be provided in SCILLC data sheets and/or specifications can and do vary in different applications and actual performance may vary over time. All operating parameters, including "Typicals" must be validated for each customer application by customer's technical experts. SCILLC does not convey any license under its patent rights nor the rights of others. SCILLC products are not designed, intended, or authorized for use as components in systems intended for surgical implant into the body, or other applications intended to support or sustain life, or for any other application in which the failure of the SCILLC product could create a situation where personal injury or death may occur. Should Buyer purchase or use SCILLC products for any such unintended or unauthorized application, Buyer shall indemnify and hold SCILLC and its officers, employees, subsidiaries, affiliates, and distributors harmless against all claims, costs, damages, and expenses, and reasonable attorney fees arising out of, directly or indirectly, any claim of personal injury or death associated with such unintended or unauthorized use, even if such claim alleges that SCILLC was negligent regarding the design or manufacture of the part. SCILLC is an Equal Opportunity/Affirmative Action Employer.

PUBLICATION ORDERING INFORMATION

NORTH AMERICA Literature Fulfillment:

Literature Distribution Center for ON Semiconductor
 P.O. Box 5163, Denver, Colorado 80217 USA
Phone: 303-675-2175 or 800-344-3860 Toll Free USA/Canada
Fax: 303-675-2176 or 800-344-3867 Toll Free USA/Canada
Email: ONlit@hibbertco.com
 Fax Response Line: 303-675-2167 or 800-344-3810 Toll Free USA/Canada

N. American Technical Support: 800-282-9855 Toll Free USA/Canada

EUROPE: LDC for ON Semiconductor – European Support

German Phone: (+1) 303-308-7140 (Mon-Fri 2:30pm to 7:00pm CET)
Email: ONlit-german@hibbertco.com
French Phone: (+1) 303-308-7141 (Mon-Fri 2:00pm to 7:00pm CET)
Email: ONlit-french@hibbertco.com
English Phone: (+1) 303-308-7142 (Mon-Fri 12:00pm to 5:00pm GMT)
Email: ONlit@hibbertco.com

EUROPEAN TOLL-FREE ACCESS*: 00-800-4422-3781

*Available from Germany, France, Italy, UK, Ireland

CENTRAL/SOUTH AMERICA:

Spanish Phone: 303-308-7143 (Mon-Fri 8:00am to 5:00pm MST)
Email: ONlit-spanish@hibbertco.com
Toll-Free from Mexico: Dial 01-800-288-2872 for Access –
 then Dial 866-297-9322

ASIA/PACIFIC: LDC for ON Semiconductor – Asia Support

Phone: 1-303-675-2121 (Tue-Fri 9:00am to 1:00pm, Hong Kong Time)
Toll Free from Hong Kong & Singapore:
001-800-4422-3781
Email: ONlit-asia@hibbertco.com

JAPAN: ON Semiconductor, Japan Customer Focus Center

4-32-1 Nishi-Gotanda, Shinagawa-ku, Tokyo, Japan 141-0031
Phone: 81-3-5740-2700
Email: r14525@onsemi.com

ON Semiconductor Website: <http://onsemi.com>

For additional information, please contact your local Sales Representative.